



SLO / CRO / GER / ENG

Opisni katalog
Vorstellungskatalog
Description catalog

TIPSKJE HIŠE

STELA ANGLE *line*

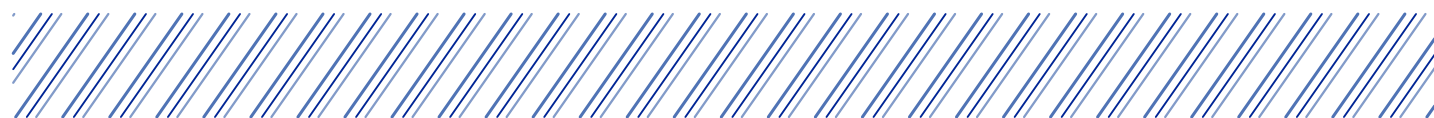



STELA ANGLE A_{90}

PRITLIČNA HIŠA / PRIZEMNICA / HAUS IM ERDGESCHOSS / GROUND FLOOR HOUSE

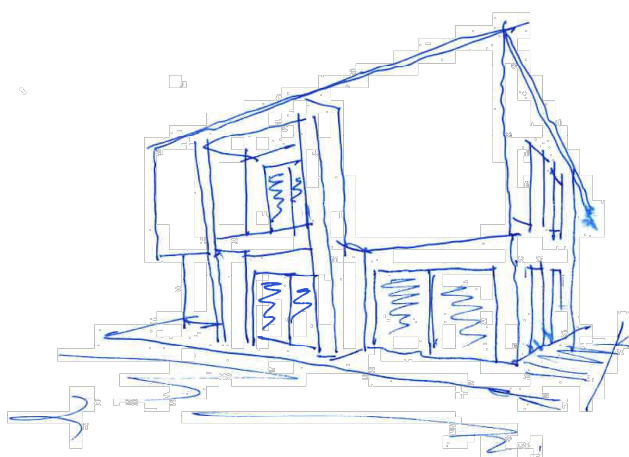
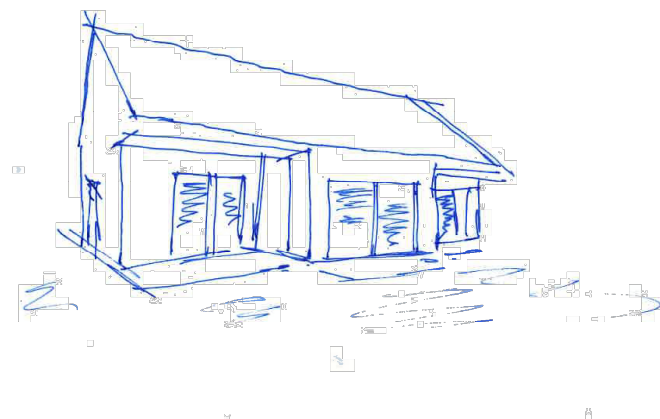

STELA ANGLE A_{170}

NADSTROPNA HIŠA / KUĆA NA KAT / STOCKIGES HAUS / STORY HOUSE

VSEBINA

SADRŽAJ

INHALT

CONTENT

kazalo / kazalo / Index / index	II
tip / tip / Typ / type Angle A₉₀	
splošni podatki / opći podaci / Allgemeine Daten / general data	IV
tloris pritličja / tlocrt prizemlja / Erdgeschossplan / ground floor plan	V
fasade / pročelja / Fassaden / facades	VI
tehnični podatki / tehničke informacije / Technische information / technical information	VII
pogled / pogled / sicht / view	VIII
variante / varijante / variante / variant	IX
variante / varijante / variante / variant	X
tip / tip / Typ / type Angle A₁₇₀	
splošni podatki / opći podaci / Allgemeine Daten / general data	XII
tloris pritličja / tlocrt prizemlja / Erdgeschossplan / ground floor plan	XIII
tloris mansarde / tlocrt potkrovlja / Mansarde / mansard	XIV
fasade / pročelja / Fassaden / facades	XV
pogled / pogled / sicht / view	XVI
tehnični podatki / tehničke informacije / Technische information / technical information	XVII
pogled / pogled / sicht / view	XVIII
variante / varijante / variante / variant	XIX
variante / varijante / variante / variant	XX
variante / varijante / variante / variant	XXI
variante / varijante / variante / variant	XXII



STELA
ANGLE A₉₀

PRITLIČNA HIŠA / PRIZEMNICA / HAUS IM ERDGESCHOSS / GROUND FLOOR HOUSE



SPLOŠNI PODATKI

OPĆI PODACI
ALLGEMEINE DATEN
GENERAL DATA

SHEMA / PLANEN / SCHEME

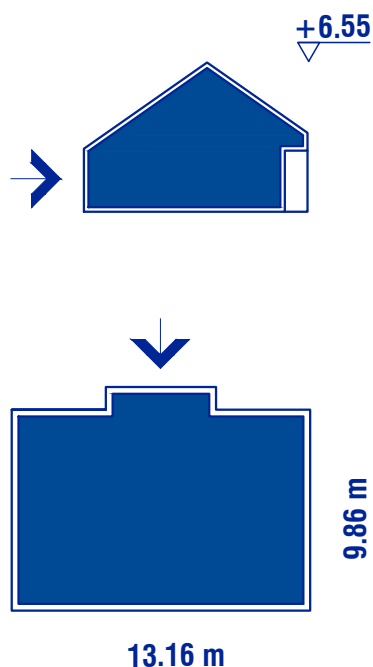

ZMOGLJIVOST OBJEKTA / KAPACITET OBJEKTA / KAPAZITAT DER ANLAGE / FACILITY CAPACITY

Gabarit / tlocrt / Gebäudeplan / floor plan	13.16 x 9.86 m
Neto površina / neto površina / Nettofläche / neto area	88.3 m²
Terase / terase / Terrasse / terrace	9.0 m²
Zazidalna površina / tlocrtna površina / Baufläche / building area	121.5 m²
Bruto površina / bruto površina / Bruttofläche / bruto area	121.5 m²
Etažnost / kat / Boden / floor	1
Višina / visina / Höhe / height	6.55 m
Streha / krov / Dach / roof	35° - ±5°
Debelina zidu / debljina zida / Wandstärke / wall thickness	36 - 43 cm

Dodatne možnosti / dodatne opcije / Zubehöroptionen / options

Nadstrešnica za avte / nadstrešnica za automobil / Carport / carport	cca. 45.0 m²
Razširitev teras / proširenje terase / Terrassenerweiterung / terrace expansion	



STELA
ANGLE A₉₀

T L O R I S P R I T L I Č J A
TLOCRT PRIZEMLJA
ERDGESCHOSSPLAN
GROUND FLOOR PLAN



1	6.4 m²	predprostor / predulaz / Lobby / lobby
2	4.3 m²	tehnika / tehnika / technischer Raum / technical room
3	2.4 m²	wc
4	7.1 m²	hodnik / hodnik / Flur / hall
5	10.6 m²	kuhinja / kuhinja / Küche / kitchen
6	17.0 m²	jedilnica / blagovaonica / Esszimmer / dining room
7	16.0 m²	dnevna soba / dnevna soba / Wohnzimmer / living room
8	12.0 m²	spalnica / spavaća soba / Schlafzimmer / bedroom
9	8.5 m²	kabinet / kabinet / Kabinett / cabinet
10	4.0 m²	kopalnica / kupaonica / Badezimmer / bathroom
Σ =	88.3 m²	
	9.0 m²	terase / terasa / Terrasen / terraces

FASADE

PROČELJA
FASSADEN
FACADES

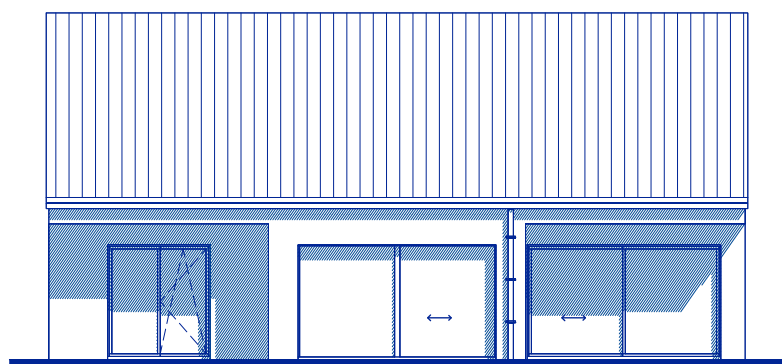
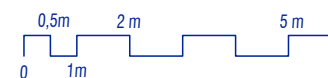

jug / jug / Sud / south

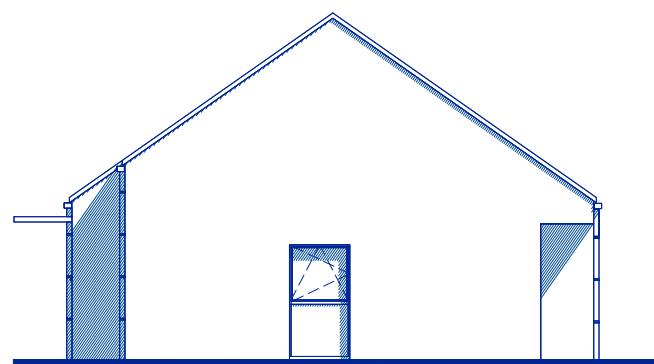

zahod / zapad / West / west

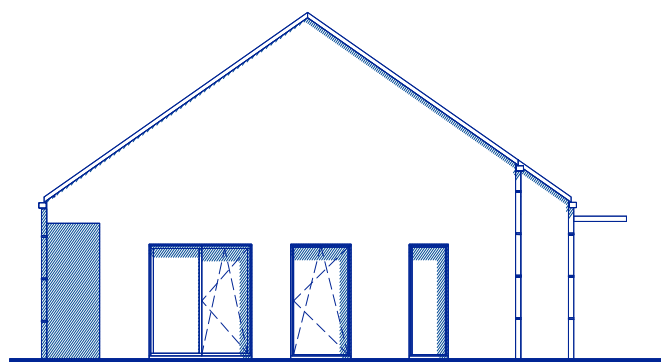

vzhod / istok / Ost / east

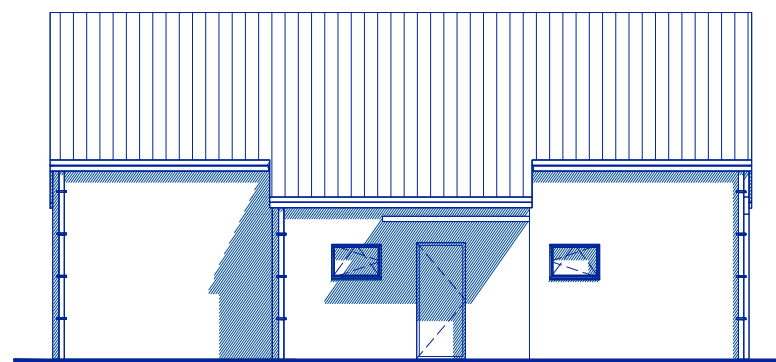

sever / sjever / Nord / north



STELA
ANGLE A₉₀

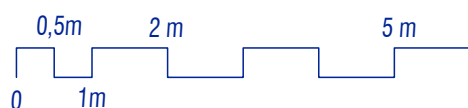

tloris / tlocrt / gebäudeplan / floor plan

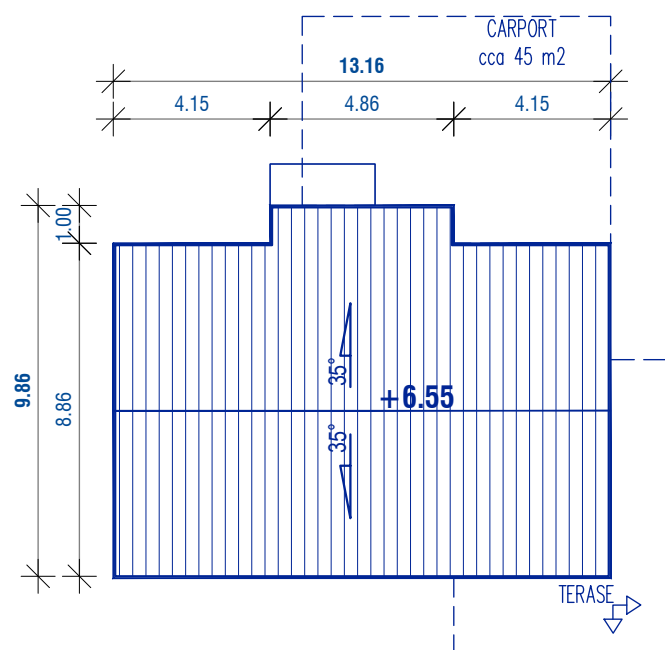

zrcaljenje / zrcaljenje / Spiegelung / mirroring

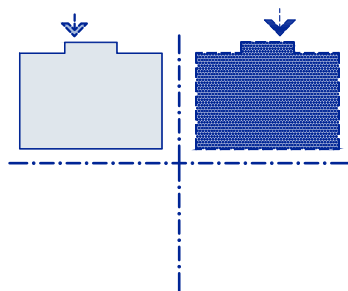

TEHNIČNI PODATKI
TEHNIČKE INFORMACIJE
TECHNISCHE INFORMATION
TEHNICAL INFORMATION

prerez / presjek / Querschnitt / cross section

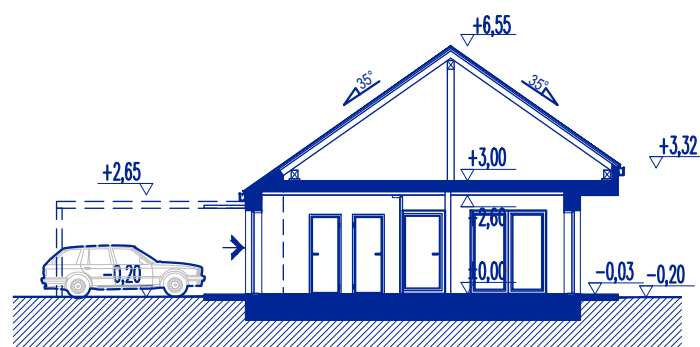

rotacija / rotacija / Drehung / rotation

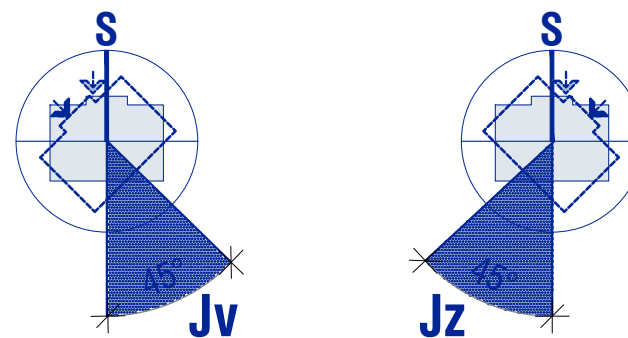

POGLED

POGLED
SICHT
VIEW





STELA
ANGLE A₉₀

VARIANTE
VARIANTE
VARIANTE
VARIANT



ZMANJŠAN TLOORIS / SMANJENI TLOORCT / REDUZIERTER GRUNDRISS / REDUCED FLOOR PLAN

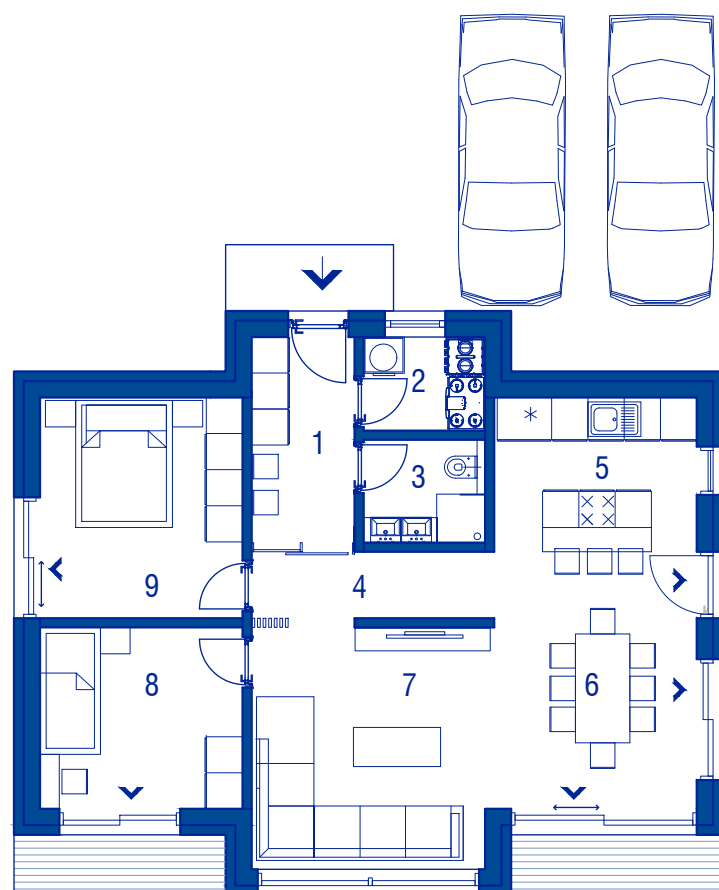

Gabarit / tloorct / Gebäudeplan / floor plan **11.72 x 7.66 m**
Neto površina / neto stambena / Nettofläche / neto area **77.3 m²**
Terase / terase / Terrasse / terrace **7.0 m²**



0,5m 2 m 5 m
0 1m

- | | | |
|-------------------------------|---------------------------|--|
| 1 | 6.0 m² | predprostor / predulaz / Lobby / lobby |
| 2 | 3.1 m² | tehnika / tehnika / technischer Raum / technical room |
| 3 | 3.4 m² | kopalnica / kupaonica / Badezimmer / bathroom |
| 4 | 4.4 m² | hodnik / hodnik / Flur / hall |
| 5 | 8.5 m² | kuhinja / kuhinja / Küche / kitchen |
| 6 | 14.2 m² | jedilnica / blagovaonica / Esszimmer / dining room |
| 7 | 15.5 m² | dnevna soba / dnevna soba / Wohnzimmer / living room |
| 8 | 10.0 m² | soba / soba / Zimmer / room |
| 9 | 12.2 m² | spalnica / spavaća soba / Schlafzimmer / bedroom |
| Σ = 77.3 m² | | |
| | 7.0 m² | terase / terasa / Terrassen / terraces |

STREHE / KROVOVI / DACHER / ROOFS

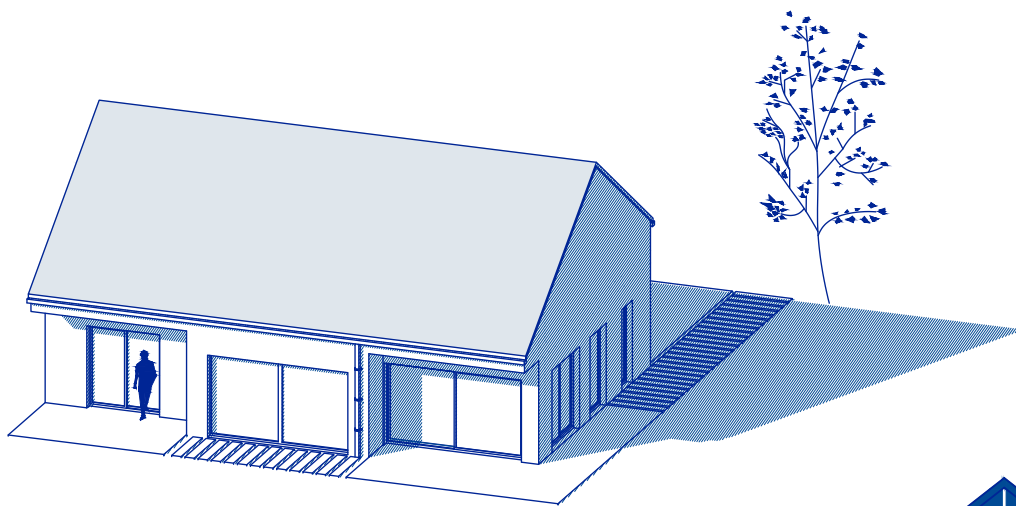

dvokapna streha / dvostrešni krov / Satteldach / gable roof

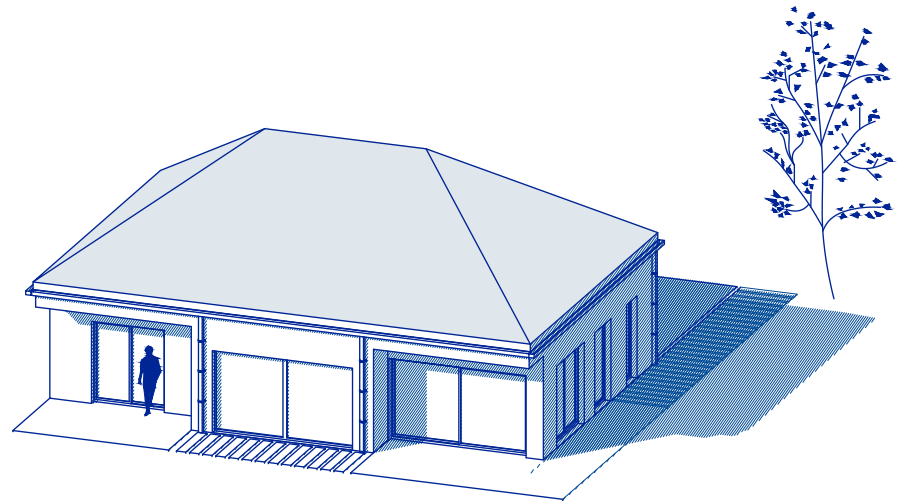

večkapnica / višestrešni krov / Walmadach / multi pitched roof



STELA ANGLE A₁₇₀

NADSTROPNA HIŠA / KUĆA NA KAT / STOCKIGES HAUS / STORY HOUSE

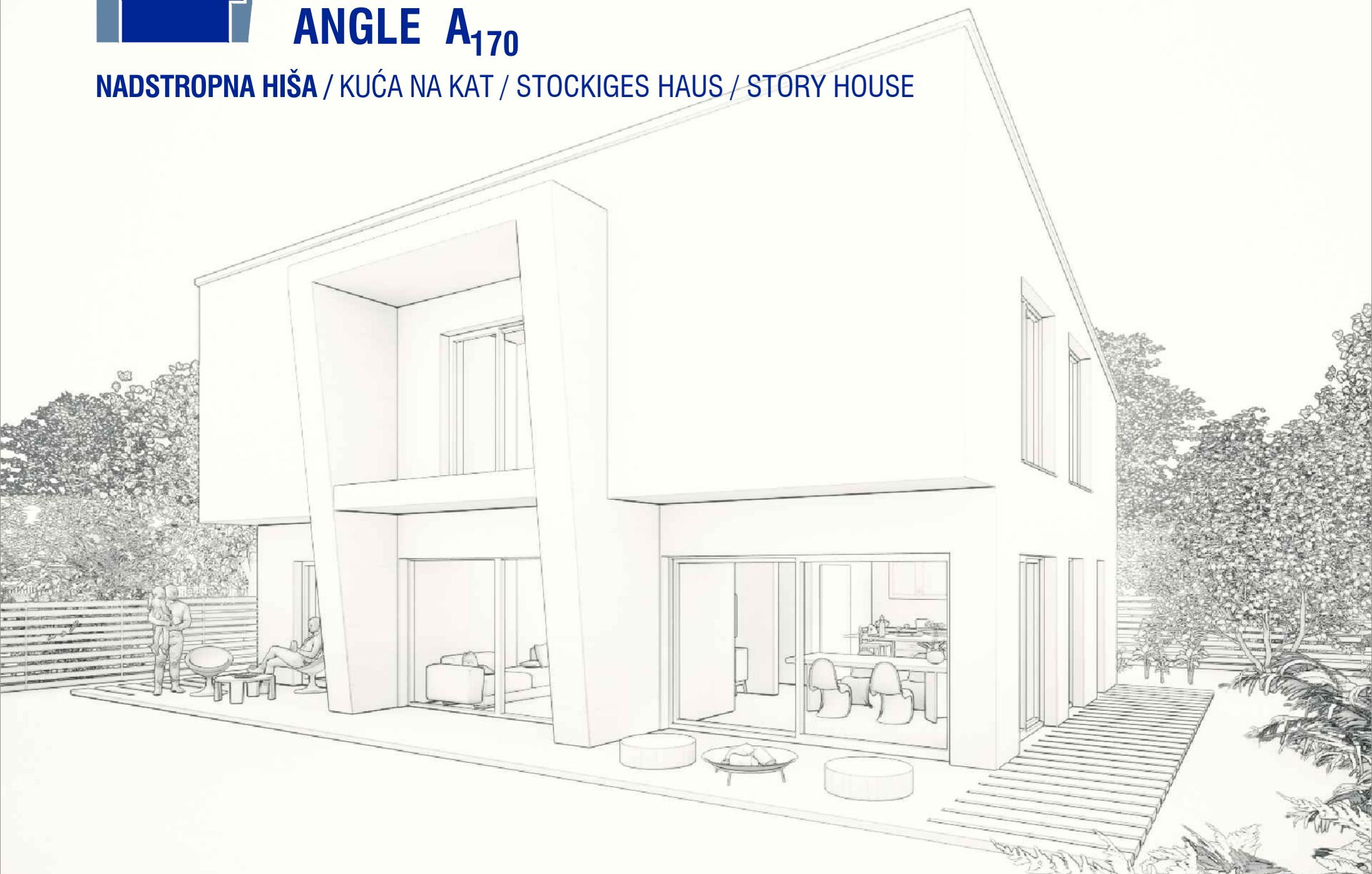

SPLOŠNI PODATKI

OPĆI PODACI

ALLGEMEINE DATEN

GENERAL DATA

SHEMA / PLANEN / SCHEME

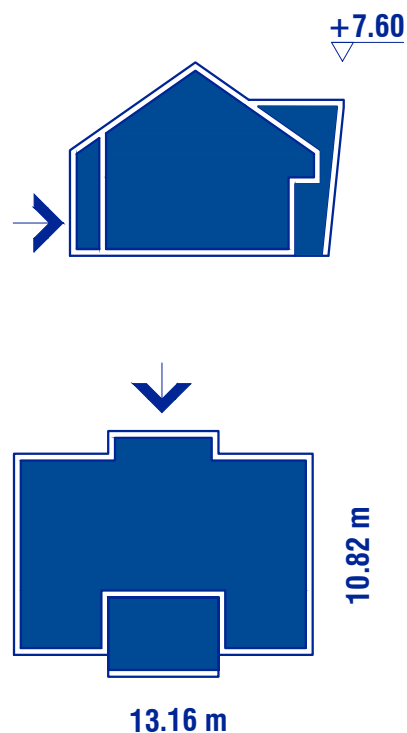

ZMOGLJIVOST OBJEKTA / KAPACITET OBJEKTA / KAPAZITAT DER ANLAGE / FACILITY CAPACITY

Gabarit / tlocrt / Gebäudeplan / floor plan	13.16 x 10.82 m
Neto površina / neto površina / Nettofläche / neto area	171.5 m²
Terase / terase / Terrasse / terrace	15.5 m²
Zazidalna površina / tlocrtna površina / Baufläche / building area	122.9 m²
Bruto površina / bruto površina / Bruttofläche / bruto area	249.3 m²
Etažnost / kat / Boden / floor	2
Višina / visina / Höhe / height	7.60 m
Streha / krov / Dach / roof	35° - ±5°
Debelina zidu / debljina zida / Wandstärke / wall thickness	36 - 43 cm

Dodatne možnosti / dodatne opcije / Zubehöroptionen / options

Nadstrešnica za avte / nadstrešnica za automobil / Carport / carport	cca. 45.0 m²
Razširitev teras / proširenje terase / Terrassenerweiterung / terrace expansion	



STELA ANGLE A₁₇₀

T L O R I S P R I T L I Č J A T L O C R T P R I Z E M L J A E R D G E S C H O S S P L A N G R O U N D F L O O R P L A N

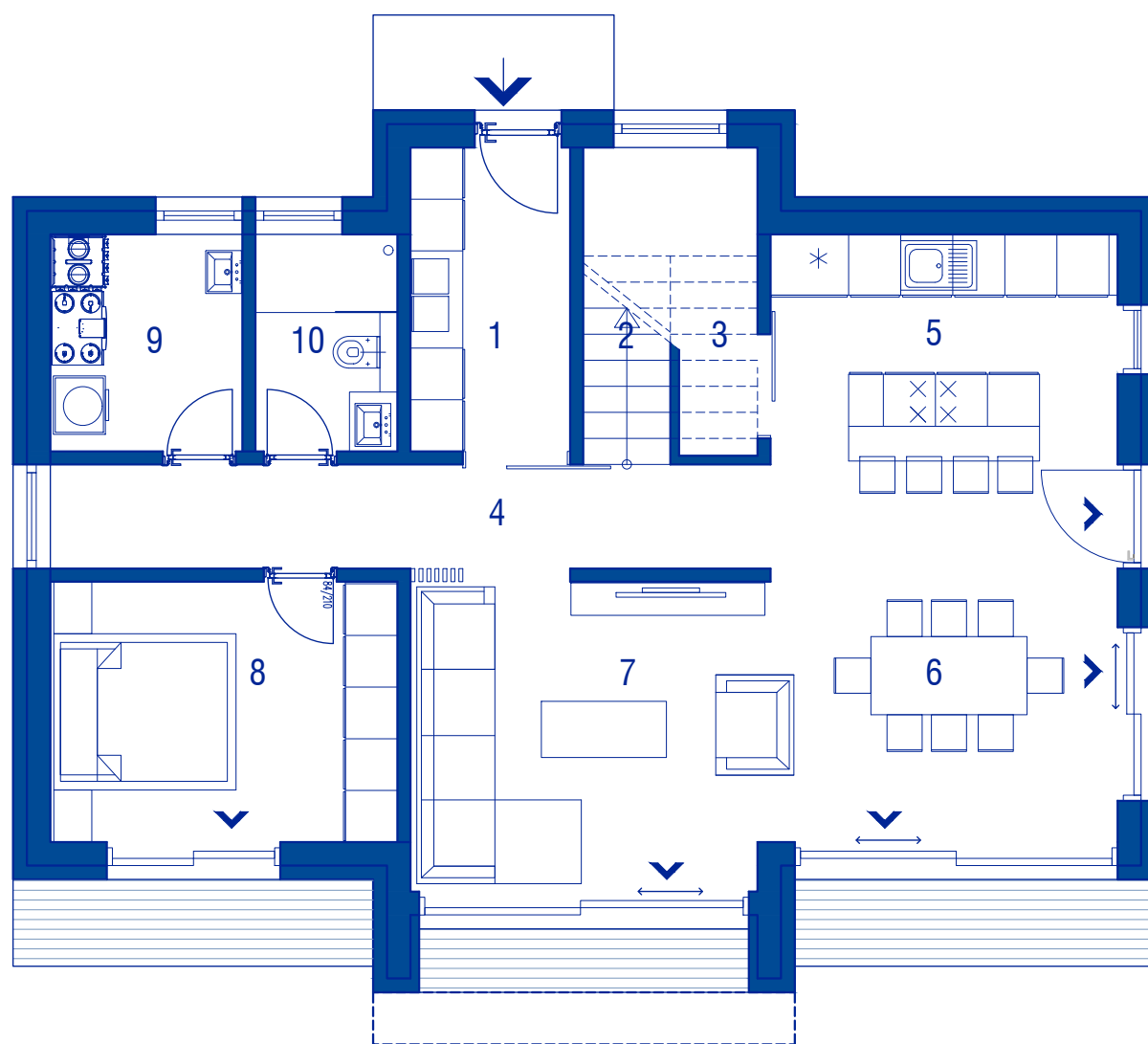

1	6.4 m ²	predprostor / predulaz / Lobby / lobby
2	3.6 m ²	stopnice / stepenice / Treppe / stairs
3	3.1 m ²	shramba / shramba / Lagerraum / storage room
4	9.9 m ²	hodnik / hodnik / Flur / hall
5	10.6 m ²	kuhinja / kuhinja / Küche / kitchen
6	17.0 m ²	jedilnica / blagovaonica / Esszimmer / dining room
7	14.5 m ²	dnevna soba / dnevna soba / Wohnzimmer / living room
8	12.0 m ²	spalnica / spavaća soba / Schlafzimmer / bedroom
9	5.5 m ²	tehnika / tehnika / technischer Raum / technical room
10	4.0 m ²	kopalnica / kupaonica / Badezimmer / bathroom
Σ =	86.6 m²	
	11.7 m ²	terase / terasa / Terrasen / terraces

T L O R I S M A N S A R D E

TLOCRT POTKROVLJA

MANSARDE

MANSARD

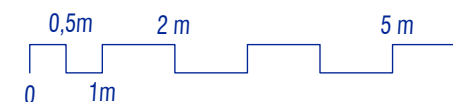
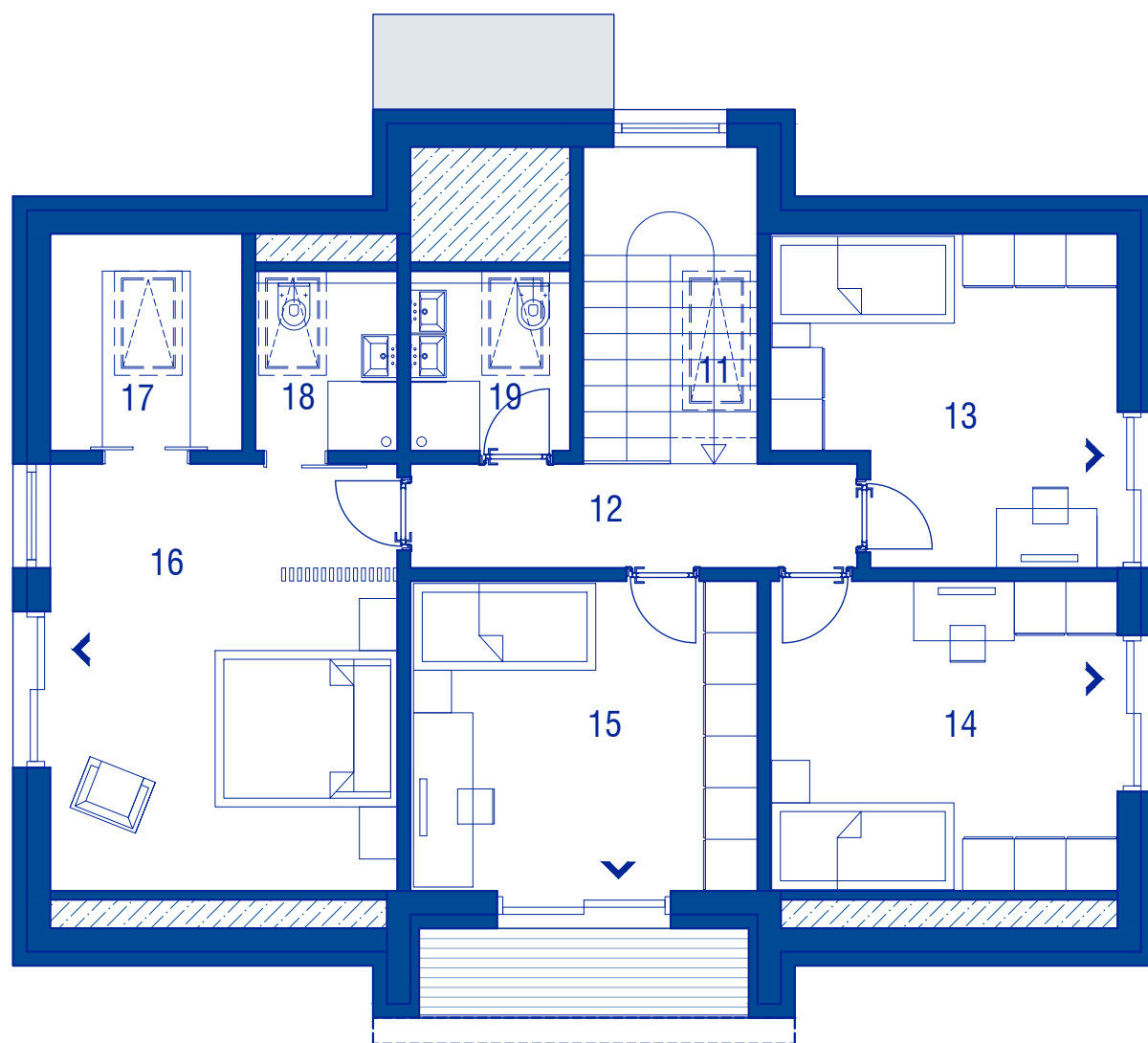

11	4.0 m²	stopnice / stepenice / Treppe / *stairs
12	6.2 m²	hodnik / hodnik / Flur / hall
13	13.8 m²	soba / soba / Zimmer / room
14	14.3 m²	soba / soba / Zimmer / room
15	14.3 m²	soba / soba / Zimmer / room
16	19.6 m²	spalnica / spavaća soba / Schlafzimmer / bedroom
17	5.5 m²	garderoba / garderoba / Garderobe / dressing room
18	3.4 m²	kopalnica / kupaonica / Badezimmer / bathroom
19	3.8 m²	kopalnica / kupaonica / Badezimmer / bathroom
Σ = 84.9 m²		
	3.8 m²	terase / terasa / Terrasen / terraces



STELA ANGLE A₁₇₀

FASADE
PROČELJA
FASSADEN
FACADES

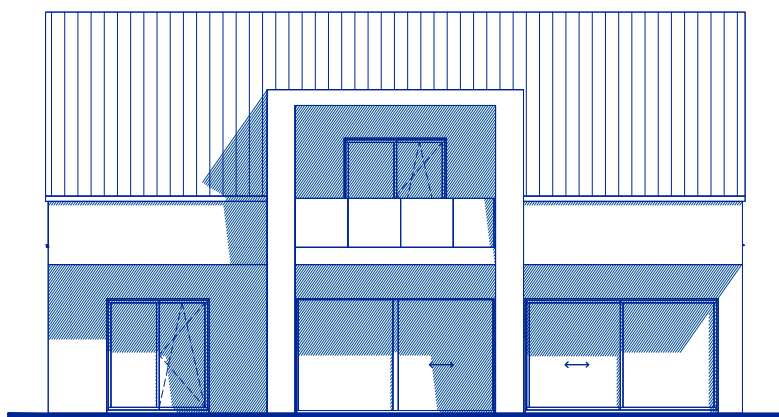

jug / jug / Sud / south



zahod / zapad / West / west

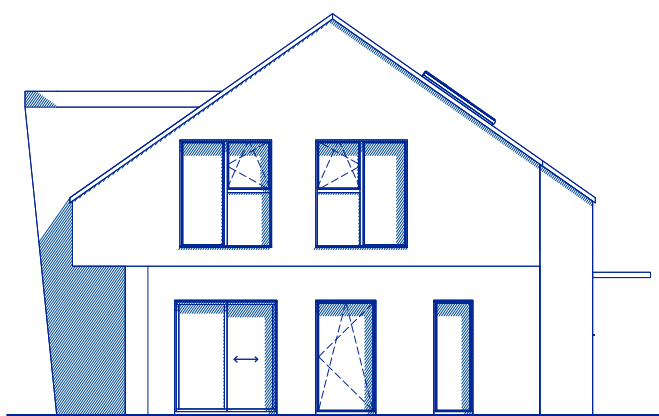

vzhod / istok / Ost / east

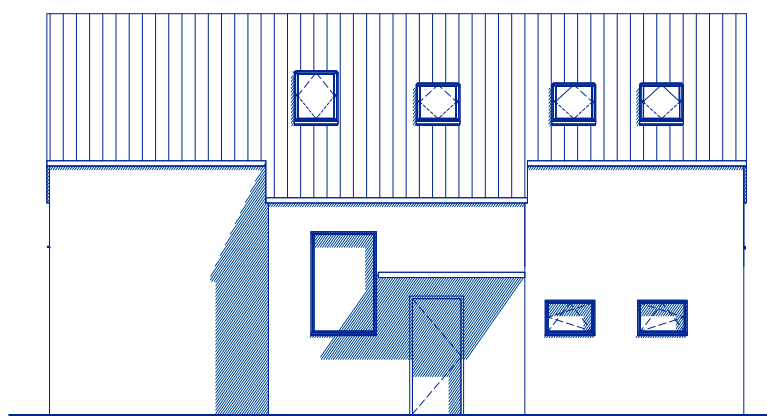

sever / sjever / Nord / north

POGLED
POGLED
SICHT
VIEW





STELA ANGLE A₁₇₀

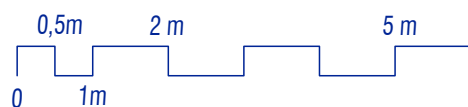

tloris / tlocrt / gebaudeplan / floor plan

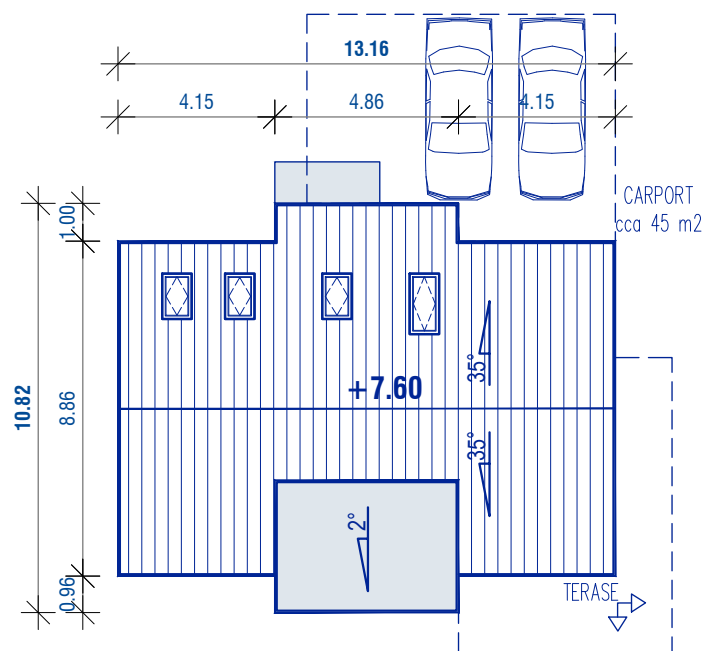

zrcaljenje / zrcaljenje / Spiegelung / mirroring

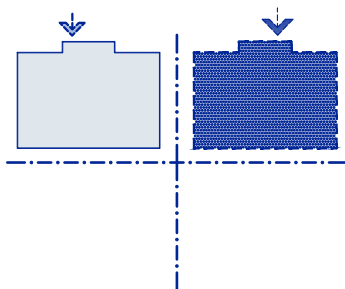

TEHNIČNI PODATKI TEHNIČKE INFORMACIJE TECHNISCHE INFORMATION TEHNICAL INFORMATION

prerez / presjek / Querschnitt / cross section

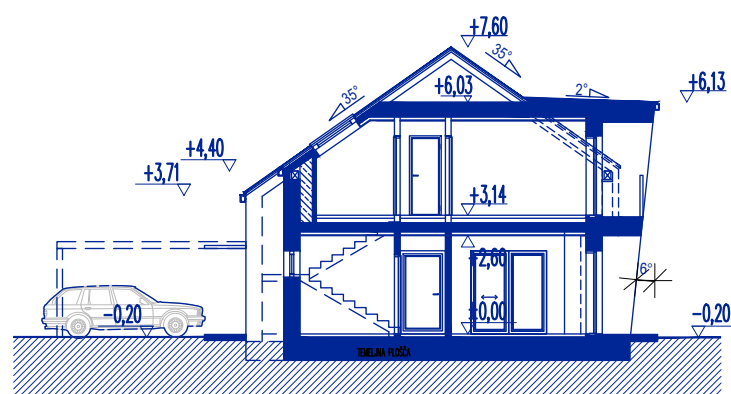

rotacija / rotacija / Drehung / rotation

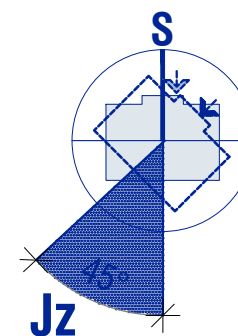
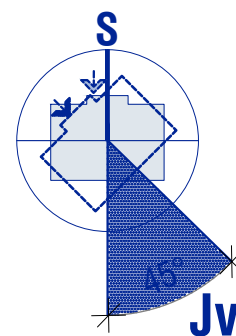

POGLED

POGLED
SICHT
VIEW





STELA ANGLE A₁₇₀

VARIANTE
VARIANTE
VARIANTE
VARIANT



ZMANJŠAN TLOORIS / SMANJENI TLOORCT / REDUZIERTER GRUNDRISS / REDUCED FLOOR PLAN

Gabarit / tloorct / Gebäudeplan / floor plan **11.72 x 8.96 m**
Neto površina / neto stambena / Nettofläche / neto area **147.5 m²**
Terase / terase / Terrasse / terrace **10.8 m²**

tlooris pritličja / tloorct prizemlja / erdgeschossplan / ground floor plan

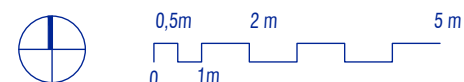

1	5.8 m²	predprostor / predulaz / Lobby / lobby
2	3.1 m²	stopnice / stepenice / Treppe / stairs
3	3.1 m²	shramba / shramba / Lagerraum / storage room
4	8.2 m²	hodnik / hodnik / Flur / hall
5	8.5 m²	kuhinja / kuhinja / Küche / kitchen
6	14.2 m²	jedilnica / blagovaonica / Esszimmer / dining room
7	14.3 m²	dnevna soba / dnevna soba / Wohnzimmer / living room
8	10.0 m²	kabinet / kabinet / Kabinett / cabinet
9	4.0 m²	tehnika / tehnika / technischer Raum / technical room
10	3.7 m²	kopalnica / kupaonica / Badezimmer / bathroom
Σ = 74.9 m²		
	9.6 m²	terase / terasa / Terrasen / terraces

tloris mansarde / tlocrt potkrovlja / Mansarde / mansard

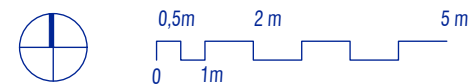
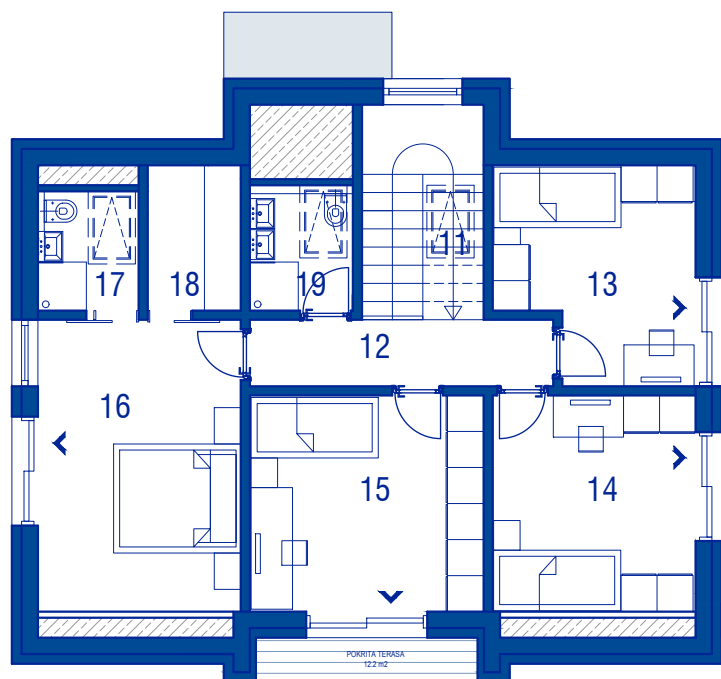

11	4.0 m²	stopnice / stepenice/ Treppe / Stairs
12	5.5 m²	hodnik / hodnik / Flur / hall
13	10.8 m²	soba / soba / Zimmer / room
14	11.9 m²	soba / soba / Zimmer / room
15	13.8 m²	soba / soba / Zimmer / room
16	16.1 m²	spalnica / spavaća soba / Schlafzimmer / bedroom
17	3.3 m²	kopalnica / kupaonica / Badezimmer / bathroom
18	3.7 m²	garderoba / garderoba / Garderobe / dressing room
19	3.5 m²	kopalnica / kupaonica / Badezimmer / bathroom
Σ =	72.6 m²	
	1.2 m²	terase / terasa / Terrasen / terraces



STELA ANGLE A₁₇₀

VARIANTE
VARIJANTE
VARIANTE
VARIANT

STREHE / KROVOVI / DACHER / ROOFS

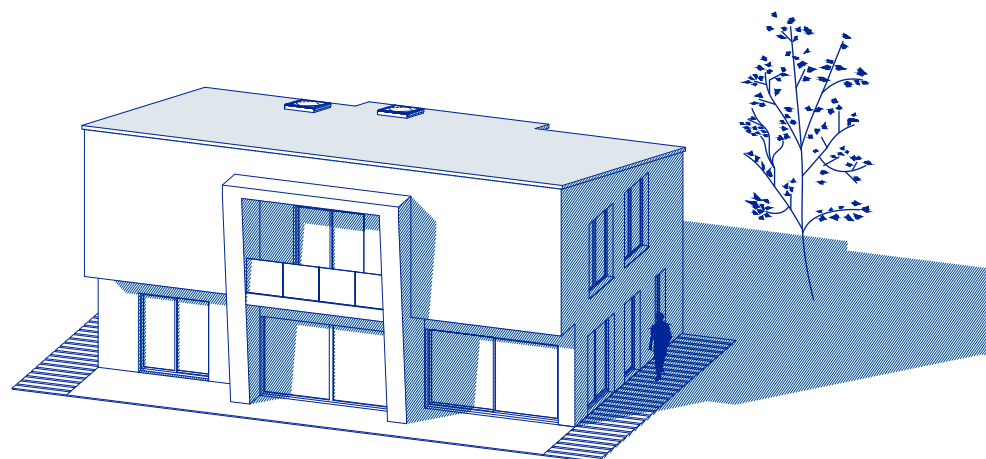

enokapna streha / jednostrešni krov / Pultdach / single pitched roof

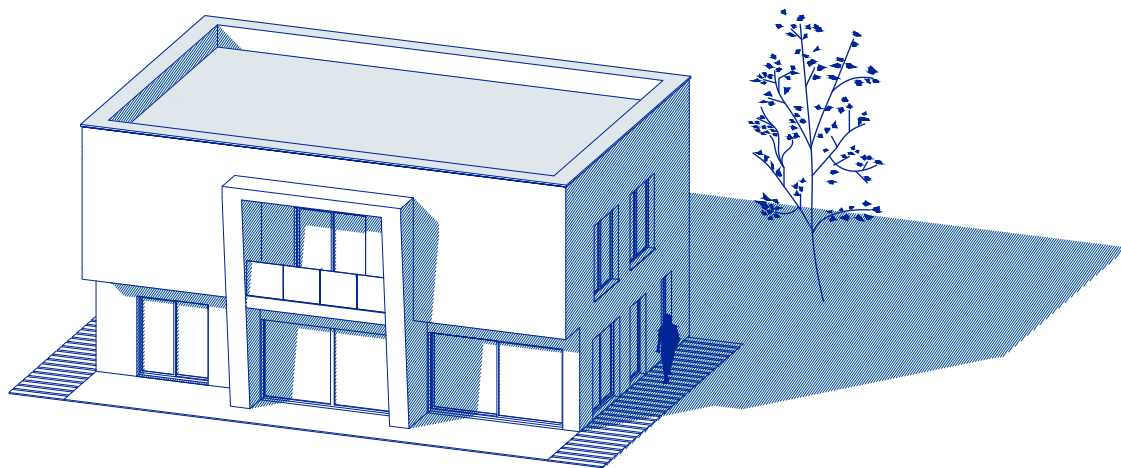

 **ravna streha** / ravni krov / Flachdach / flat roof

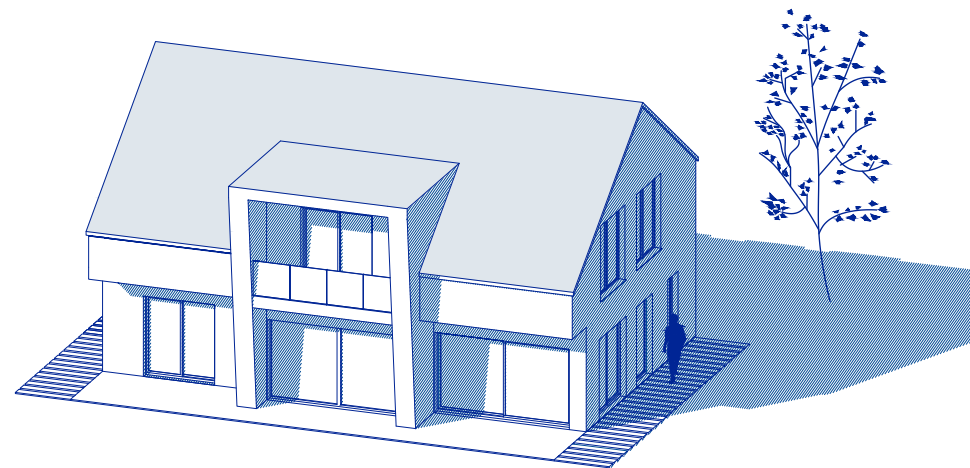

 **dvokapna streha** / dvostrešni krov / Satteldach / gable roof



STELA HAUS d.o.o.

Ljubljanska cesta 129, SI 2310 Slovenska Bistrica
Slovenija

Tel: +386 40 894 894, Email: office@stelahaus.com, Web: www.stelahaus.si

arhitektura in grafično oblikovane:

AF, UMETNOST PRIHODNOSTI MARIBOR
Partizanska cesta 36, SI 2000 Maribor,
tel: +386 31 627 307, Email: andrej.kajbic@artifuture.com

Izdelava: september 2023

OPOZORILO :

Avtorske pravice so pridržane in pripadajo podjetju Stela Haus d.o.o.. Prikazana vsebina kataloga je avtorsko delo in je zaščiten v skladu z Zakonom o avtorskih in sorodnih pravicah (ZASP). Kopiranje, predelava in obdelava vsebine ni dovoljena, razen če ni posebej odobreno in avtorizirano s strani lastnika. Vsakršne ugotovljene kršitve bo Stela Haus d.o.o. kazensko in materialno preganjala.

